

CATALOGO PRODOTTI



INTORNO
AL CIBO



“Il successo inizia dalla passione
per il proprio lavoro”

indice

BREAKFAST	1
PANE	2
SAVOURY	3
TORTELLI	4
SELVAGGINA	5
PESCE	6
DESSERT	7
COMPLEMENTI	8

BREAKFAST

*"Solo gli ottusi sono brillanti
la mattina a colazione."*

Oscar Wilde



MIGNON - p. 8 ●

GRANDE - p. 10 ●

MIGNON

MIGNON



BR32956
Mini croissant burro
(pz. 260)

gr. 20 cad.



BR35191
Mini croissant
(pz. 195)

gr. 30 cad.



BR35681
Croissant mignon multi-semi
(pz. 180)

gr. 35 cad.



BR31507
Mix mini sfogliatelle frutta
(pz. 100)

gr. 40 cad.



CS1861
Mini krapfen crema
(pz. 120)

gr. 25 cad.



CS1862
Mini krapfen vuoto
(pz. 170)

gr. 15 cad.



CS41181
Mini croissant cereali
(pz. 150)

gr. 25 cad.



BR30122
Mini pain au chocolat
(pz. 260)

gr. 28 cad.



BR37822
Mini pain au chocolat
(pz. 240)

gr. 32 cad.



PF5000971
Mini noci pecan
(pz. 100)

gr. 40 cad.

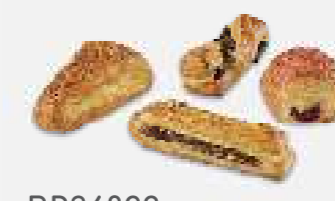

BR36822
Mini mix pralinati lamponi, crema,
cioccolato - (pz. 200)

gr. 35 cad.



BR38257
Sfoglia mini "confetti" mix. (limone,
fragola, mandorle, pralin, cioccolato
(pz. 150)

gr. 30 cad.



BR31701
Mini treccia cioccolato
(pz. 100)

gr. 28 cad.

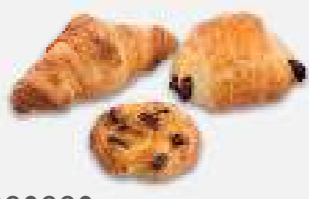

BR30220
Mix mignon pain/girella/croissant
(pz. 135)

gr. 45 cad.



BR32183
Mini girella uvetta
(pz. 260)

gr. 30 cad.



PF5001287
Mix mini muffin
(pz. 180)

gr. 15 cad.



PF5001500
Mini pan cakes

gr. 8 cad.



PF5001501
Mini waffle
(pz. 120)

gr. 15 cad.



BR32330
Mini fagottino crema
(pz. 180)

gr. 40 cad.



BR36734
Mix girelle caramello, tart tatin,
cioccolato - (pz. 180)

gr. 60 cad.



BR32232
Mix mini gourmandises dolci
(pz. 140)

gr. 35 cad.



PF5001676
Mini brioche buon
(pz. 110)

gr. 10 cad.

GRANDE

GRANDE



BR30458
Croissant
(pz. 60)

gr. 70 cad.



BR32960
Croissant 100% burro
(pz. 120)

gr. 50 cad.



BR34161
Croissant 100% burro
(pz. 70)

gr. 60 cad.



BR32063
Saccottino alla crema
(pz. 70)

gr. 90 cad.



BR36967
Bun'n roll al burro
(pz. 50)

gr. 85 cad.



CS1387
Krapfen vuoto
(pz. 36)

gr. 50 cad.



BR34732
Croissant cereali
(pz. 70)

gr. 70 cad.



BR36670
Croissant super farcito albicocca
(pz. 44)

gr. 90 cad.



BR36671
Croissant super farcito lampone
(pz. 44)

gr. 90 cad.



BR30308
Treccia al cioccolato
(pz. 70)

gr. 90 cad.



BR34044
Treccia al lampone
(pz. 70)

gr. 85 cad.



BR34045
Treccia albicocca
(pz. 70)

gr. 85 cad.



BR36672
Croissant super farcito cacao
noisette - (pz. 44)

gr. 90 cad.

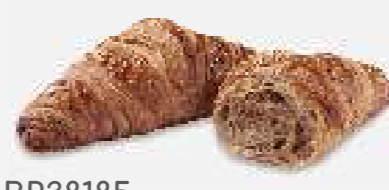

BR38185
Croissant campagnolo 100% burro
(pz. 70)

gr. 70 cad.

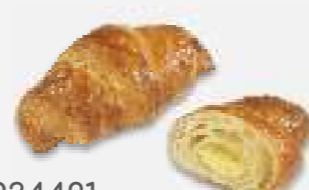

BR34421
Croissant ripieno mandorla
(pz. 60)

gr. 90 cad.



PF5000662
Muffin vaniglia confezioni
(pz. 40)

gr. 90 cad.



PF5000677
Muffin doppio cioccolato
(pz. 40)

gr. 90 cad.



PF5000678
Muffin mirtillo
(pz. 40)

gr. 90 cad.



BR30147
Pain au chocolat
(pz. 90)

gr. 70 cad.



BR37959
Pain au chocolat 3 cioccolati
(pz. 60)

gr. 95 cad.



BR31002
Girella con uvetta
(pz. 60)

gr. 110 cad.



BR37744
Fagottino muesli e mirtillo
(pz. 60)

gr. 95 cad.



PF5000731
Treccia di noci pecan
(pz. 48)

gr. 95 cad.



PF5000105
Waffle artigianali
(pz. 32)

gr. 90 cad.

PANE

"Il pane è il re della tavola e tutto il resto è solo la corte che lo circonda."

Louis Bromfield



MIGNON - p. 14 ●

GRANDE - p. 16 ●

FOCACCINE - p. 18 ●

SENZA GLUTINE - p. 18 ●

PANE CASSETTA - p. 19 ●

MIGNON

MIGNON



PEP01
Pepite neutre
(pz. 320)

gr. 13 cad.



BOX04
Box misto pepite
(pz. 320)

gr. 13 cad.



PF50001376
Mini paninetti soft roll
(pz. 231)

gr. 17 cad.



BR36767
Finedor campagnolo
(pz. 50)

gr. 45 cad.



BR37628
Bocconcino di pane ai semi e cereali
(pz. 65)

gr. 50 cad.



BR35130
Panino rustico
(pz. 70)

gr. 55 cad.



PAN18
Mini panini al latte
(pz. 150)

gr. 20 cad.



CT4829
Bogel mini naturale
(pz. 50)

gr. 40 cad.



KAI04
Mini kaiser
(pz. 120)

gr. 35 cad.



BR33417
Mini panino campagna
(pz. 130)

gr. 50 cad.



BR34921
Pane naturale
(pz. 200)

gr. 40 cad.



BR37970
Mix mini panini
(pz. 90)

gr. 45 cad.



C7008
Mini bretzel misti
(pz. 120)

gr. 25 cad.



BR30895
Mini baguette
(pz. 50)

gr. 45 cad.



BR31692
Pane Finedor Spiga
(pz. 40)

gr. 40 cad.



BR34253
Stick pane olive nere (cotto)
(pz. 150)

gr. 45 cad.



BR37452
Mini panino noci e nocciole
(pz. 75)

gr. 55 cad.



CT70576
Suprema mini pincio "doppia
lievitazione" - 5 kg/cf - (pz. 200)

gr. 25 cad.



BR33994
Pane piccolo al segale
(pz. 50)

gr. 50 cad.



BR30898
Panino ai semi-cereali
(pz. 60)

gr. 45 cad.



BR31480
Pane segale
(pz. 60)

gr. 45 cad.



CT70317
Suprema pincio "doppia lievitazione"
grande - 3,675 kg/cf - (pz. 105)

gr. 35 cad.

GRANDE

GRANDE



BR33364
Baguette rustica
(pz. 25)

gr. 280 cad.



BR33365
Pane "Batard"
(pz. 14)

gr. 540 cad.



BR33367
Baguette lutescine con lievito
naturale - (pz. 22)

gr. 280 cad.



BR33147
Pane "pochon"
(pz. 28)

gr. 280 cad.



BR33148
Pane cereale con lievito naturale
(pz. 28)

gr. 280 cad.



BR33188
Pane integrale
(pz. 26)

gr. 330 cad.



BR38187
Baguette cereali con lievito naturale
(pz. 22)

gr. 280 cad.



BR38888
Pane ai cereali antichi
(pz. 16)

gr. 450 cad.



BR32993
Pane "Pochon"
(pz. 16)

gr. 450 cad.



BR34793
Baguette sandwich nature
(pz. 50)

gr. 140 cad.



BR34794
Francesino multisemi
(pz. 50)

gr. 140 cad.



BR38888
Francesino semi e cereali
(pz. 50)

gr. 120 cad.



BR34000
Pane di farro
(pz. 18)

gr. 450 cad.



BR34500
Pane muesli
(pz. 26)

gr. 280 cad.



BR31817
Pane multicereali
(pz. 9)

gr. 450 cad.



BR34673
Pane Pochon grande
(pz. 8)

kg. 1,1 cad.



BR34674
Pane ai cereali
(pz. 8)

kg. 1,1 cad.



CB714
Pan carré classico burro
(pz. 18)

gr. 500 cad.



BR34110
Pane segale e limone
(pz. 26)

gr. 330 cad.



BR34234
Pane alle noci
(pz. 25)

gr. 400 cad.



BR38887
Pane nordico
(pz. 26)

gr. 330 cad.



CB722
Pain brioche nature
(pz. 20)

gr. 430 cad.

FOCACCINE



FS07
Focaccia mini cereali
(pz. 100)

gr. 30 cad.



FS10
Focaccia mini bianca
(pz. 100)

gr. 30 cad.



FS11 Focaccia mini ortica (pz. 100)

FS12 Focaccia mini curry e
sesamo nero (pz. 100)

gr. 30 cad.



SP3030
Focaccia montanara precotta
(pz. 5)

gr. 390 cad.



SP3031
Schiacciata "tipo1" con lievito
naturale - (pz. 7)

gr. 500 cad.



SP3034
Focaccia al formaggio (tipo Recco)
diametro 40 cm - (pz. 6)

kg. 0,9

SENZA GLUTINE



BR35430
Madeleine
(pz. 50)

gr. 30 cad.



BR35432
Pain cereals
(pz. 50)

gr. 45 cad.



BR35433
Petit pain nature topping Millet
(pz. 50)

gr. 45 cad.

PANE CASSETTA



TRA09
Tramezzone rosso cm 52x11
(fette 10x6)

kg. 1,350x6 cf.



TRA34
Tramezzone integrale cm 52x11
(fette 10x6)

kg. 1,350x6 cf.



TRA12
Tramezzone verde cm 52x11
(fette 10x6)

kg. 1,350x6 cf.



TRA04
Tramezzone bianco cm 52x11
(fette 10x6)

kg. 1,350x6 cf.

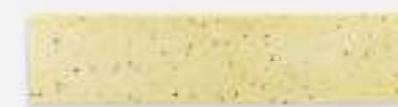

TRA130
Tramezzino curcuma e lino cm 46x10
(fette 10x6)

kg. 1,350x6 cf.



RIF10
Carrè rifilato bianco mm 15 (cm 13x13)
(fette 10x6)

kg. 1,65x4 cf.



RIF40
Carrè rifilato marrone semi mm 15
(cm 13x13) - (fette 32)

kg. 1,65x4 cf.



RIF41
Carrè rifilato mais mm 15 (cm 13x13)
(fette 32)

kg. 1,65x4 cf.



CAR17
Carrè rifilato cereali mm 15 (cm 13x13)
(fette 30)

kg. 1,65x4 cf.



CAR30
Sandwich integrale cm 13x13
(fette 36)

kg. 1,450x4 cf.



CAR31
Sandwich bianco inglese cm 12x12
(fette 36)

kg. 1,450x4 cf.

SAVOURY

“Le tartine cadono sempre dalla parte imburrata.”

La legge di Murphy



TARTELLETTE SALATE	- p. 22	●
SFOGLIATELLE	- p. 22	●
TORTE SALATE	- p. 22	●
PIZZETTE	- p. 23	●
PIZZE	- p. 23	●
PASTELLATI	- p. 24	●
ARANCINI	- p. 24	●
FUNGHI	- p. 25	●
VERDURE IN CROSTA DI GRANO	- p. 25	●

TARTELLETTE SALATE



PP01
Tartelletta mini bouchon salato
(pz. 288)

cm 3,5x1,7



PP02
Tartellette mini quadrata salata
(pz. 288)

cm 3,3x3,3



PF5000849
Mini tartellette farcite salate
(pz. 125)

gr. 18 cad.

SFOGLIATELLE



AG01
Sfogliatella salata rustica artigianale
(pz. 160 - kg. 4)

gr. 25 cad.



AG02
Sfogliatella salata zucchine
artigianale - (pz. 160 - kg. 4)

gr. 25 cad.



AG03
Sfogliatella salata melanzane
artigianale - (pz. 160 - kg. 4)

gr. 25 cad.

TORTE SALATE



SP4031
Torta patate e fagiolini artigianale
(pz. 8)

gr. 450 cad.



SP4034
Torta zucchine e cipolle artigianale
(pz. 8)

gr. 450 cad.



SP4024
Torta pasqualina artigianale
(pz. 8)

gr. 450 cad.

PIZZETTE



SP4026
Pizzette artigianali
(pz. 225)

gr. 20 cad.



PF5001680
Mini pizza cup mix
(pz. 80 ca)

gr. 25 cad.



SP4027
Solatini artigianali al burro 5 gusti
(pz. 180)

gr. 25 cad.

PIZZE



PZ11
Pizza MARGHERITA
(cf. 15 pz)

gr. 400



PZ35
Pizza VEGETARIANA
(cf. 15 pz)

gr. 450



PZ66
Pizza SALSICCIA e FRIARIELLI
(cf. 15 pz)

gr. 450



PZ486
Pizza MARGHERITA senza glutine
(cf. 15 pz)

gr. 400



PZ707
Base pizza bianca cruda
(cf. 15 pz)

gr. 250



PZ66
Base pizza rossa cruda
(cf. 15 pz)

gr. 350

PASTELLATI



LA1022
Mozzarelline panate
(pz.250)

gr. 20 cad.



LA1662
Olive ripiene ascolane prefritte
(pz. 250)

gr. 20 cad.



LA0926
Panzerotti mignon mozzarella e
pomodoro da forno - (pz. 760)

gr. 25 cad.

ARANCINI



DS01
Arancini mignon ragù artigianali
(pz. 100)

gr. 20 cad.



DS03
Arancini mignon
prosciutto/mozzarella - (pz. 100)

gr. 25 cad.



DS04
Arancini mignon
pomodoro/mozzarella - (pz. 100)

gr. 25 cad.



DS05
Arancini mignon artigianali
spinaci/mozzarella - (pz.100)

gr. 25 cad.

FUNGHI



SM01
Funghi porcini surgelati extra - TB
(ct. da kg. 5)



SM02
Funghi finferli surgelati extra - TB
(ct. da kg. 5)

VERDURA IN CROSTA DI GRANO



SC1021
Fiori di zucca pastellati in farina di
grano - (pz. 65 ca.)

kg. 4



SC1196
Salvia in pastella
(pz. 760 ca.)

kg. 4



SC1197
Tris verdure pastella (carciofi,
zucchine, cavolfiori) - (pz. 1000 ca.)

kg. 10



SC1199
Asparagina erba cipollina in crosta
(pz. 1600 ca.)

kg. 10



SC1585
Carciofini in crosta di farina di grano
(pz. 1250 ca.)

kg. 10



SC1194
Pettole al prezzemolo formaggio
(pz. 1100 ca.)

kg. 10

TORTELLI

*"La vita è una combinazione
di pasta e magia."*

Federico Fellini

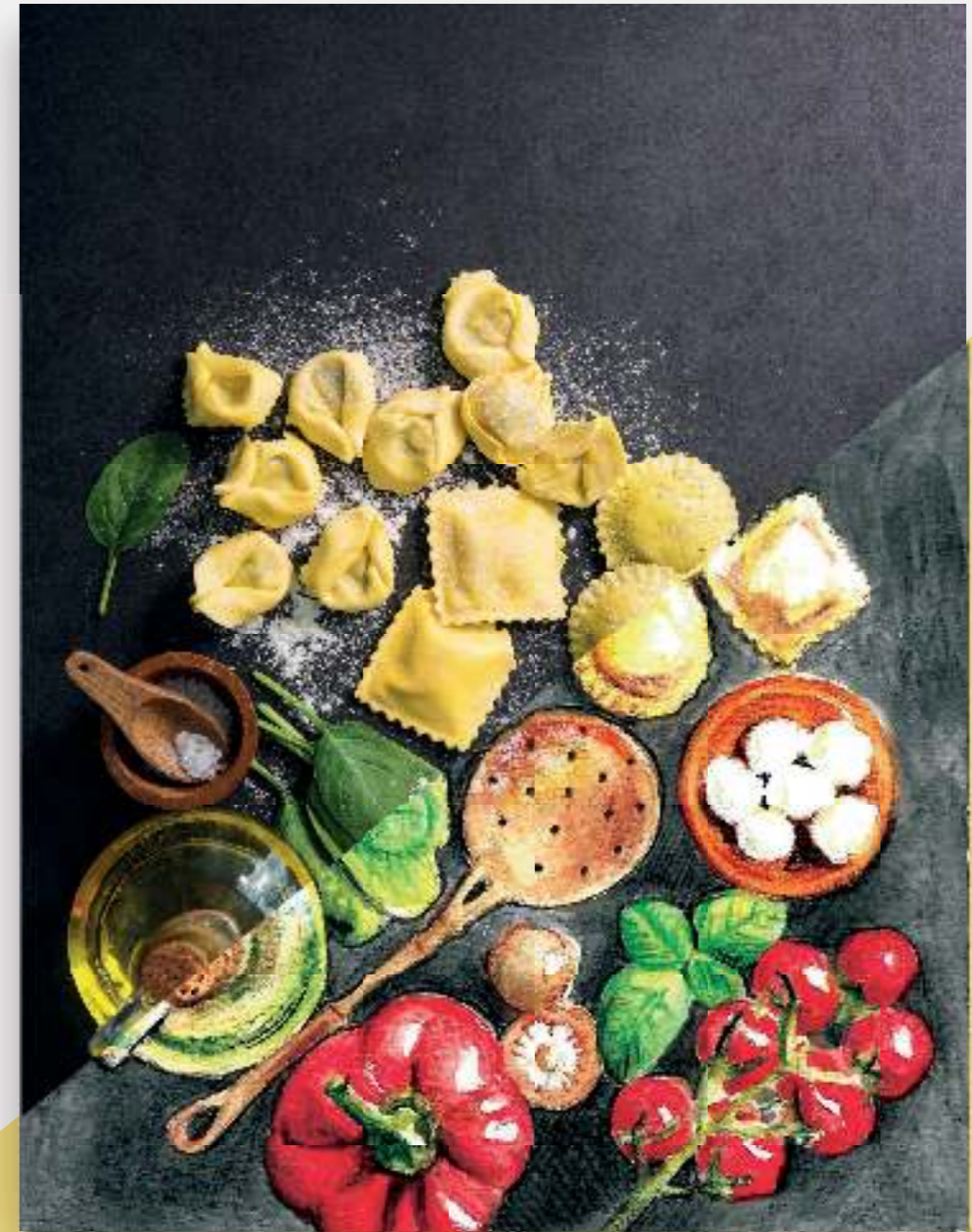

Tortelli classici e tortelli vegetariani - p. 29

TORTELLI

TORTELLO CLASSICO



QT00252560

Tortellino Modena fatti a mano

kg. 3

TORTELLI VEGETARIANI

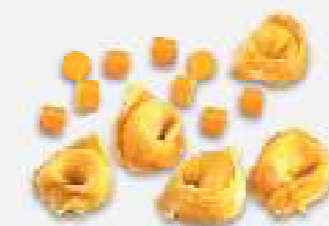

QTV02563

Tortellino di zucca fatto a mano

kg. 3



QTF0252562

Tortellino funghi porcini fatti a mano

kg. 3



QTV0252561

Tortellino spinaci e ricotta fatto a mano

kg. 3



QTSQ502598

Marubini fatti a mano sqaquerone

kg. 3

SELVAGGINA



- CINGHIALE - p. 32 ●
- CERVO - p. 32 ●
- LEPRE - p. 33 ●
- CAPRIOLO - p. 33 ●

CINGHIALE



C2340
Cinghiale spezzatino/ragù



C2343
Cinghiale bocconcini

CERVO



C2117
Cervo medaglioni



C2180
Cervo carrè Fr. Racks



C2286
Cervo osso buco

LEPRE



C2801
Lepre cosce s/o



C2828
Lepre polpa (coscia) skin

CAPRIOLO



C2410
Capriolo bocconcini goulash



C2412
Capriolo spezzatino/ragù

PESCE

"Dio creò un animale che stava sempre zitto, e disse: "Questo è muto come un pesce" e lo chiamò pesce. Poi scivolò e ci cadde sopra, e fece la sogliola."

Giobbe Covatto



PESCE

**FISH01**

Pesce BLACK CODE
(Anoplopoma Fimbria) FAO 67
Pacifico - senza testa e pulito
glassatura 2-3%

**FISH05**

Capesante non trattate
Canada 10/20
(Placopecten Magellanicus)
FAO 21 - Glassatura 2-3%

**FISH06**

Tonno SAKU non trattato super
frozen - 60 °C
(Tunnus Albacares) - FAO 51,57,71

CROSTACEI

**FISH04**

Granchio Blu KING CRAB
(Lithodes Santolla)
FAO 87 - cf.6

**FISH02**

Granchio Blu polpa artigli
(CLAW) (Portunes Pelagicus)
FAO 51,57,71 - cf.6

**FISH03**

Granchio Blu polpa BACKFIN
(Portunes Pelagicus)
FAO 51,57,71 - cf.6

DESSERT

*"La vita è breve. Mangia
il dessert per primo."*

Jacques Torres



- PASTICCERIA MIGNON - p. 40 ●
- TARTELLETTE DOLCI - p. 42 ●
- SFOGLIATELLE DOLCI - p. 42 ●
- PASTICCIOTTI - p. 43 ●
- VASSOI - p. 43 ●
- FRUTTA GELATO MIGNON - p. 44 ●
- FRUTTA GELATO - p. 45 ●
- PUREA DI FRUTTA - p. 46 ●

PASTICCERIA MIGNON

**CT26435**Mini donut's zucchero
(pz. 110)

gr. 18 cad.

**CT26510**Mini donut's cioccolato
(pz. 110)

gr. 20 cad.

**PF5001502**Mini donut's fancy mix
(pz. 112)

gr. 20 cad.

**PF5001665**Mini madleine mix 4 gusti
(pz. 160)

gr. 7,5 cad.

**MP1152**Mini bigné
(pz. 480 x 250 gr.)

gr. 1,50 cad.

**PA1517**Cannoncini mignon crudi
(pz. 120 ca.)

gr. 1,80 cad.

**BA07**Babà Micro
(pz. 500)

gr. 2 cad.

**PF5000772**Assortimento di 3 bavarese frutta e
cioccolato - (pz. 40 €44,81)

gr. 27 cad.

**PF5000841**Pasticceria mignon
(pz. 224 €134,64)

gr. 13 cad.

**PF5001363**Mini soufflé al cioccolato fondente
belga - (pz. 96 €40,32)

gr. 25 cad.

**AGS10**Caprese Mix di farine 50% mandorla
50% frumento - (cf. 90 pz. €44,10)

gr. 40 cad.

**CB 1424**Macarons assortimento classico 6
gusti - (pz. 288)

gr. 12 cad.

**AG000**Cartone da kg. 4 frolla mignon rustica
(cf. 100 pezzi - kg. 4 €55)

gr. 40 cad.

TARTELLETTE DOLCI



PP03
Tartelletta mini bouchon dolce
(pz. 288)

cm 3,5x1,7



PP07
Tartelletta mini quadrata cacao
(pz. 288)

cm 3,3x3,3



PP08
Tartelletta mini quadrata dolce
(pz. 288)

cm 3,3x3,3



PP09
Tartelletta quadrata grande dolce 7
(pz. 72)

cm 7,1x7,1 h. 2,5



PP10
Tartelletta quadrata grande cacao 7
(pz. 72)

cm 7,1x7,1 h. 2,5



PP12
Tartelletta rotonda dolce media
(pz. 120)

cm 5,5x1,7

PASTICCIOTTI



T001
Pasticcio crema
(pz. 24)

gr. 80 cad.



T002
Pasticcio crema/amarena
(pz. 24)

gr. 80 cad.



T004
Pasticcio pistacchio
(pz. 24)

gr. 80 cad.



T006
Pasticcio cioccolato
(pz. 24)

gr. 80 cad.

SFOGLIATELLE DOLCI



AG04
Sfogliatella al limone
(cf. 160 pz. - kg. 4)

gr. 30 cad.



AG05
Sfogliatella al cioccolato
(cf. 160 pz. - kg. 4)

gr. 30 cad.



AG06
Sfogliatella alla nocciola piemonte
(cf. 160 pz. - kg. 4)

gr. 30 cad.

VASSOI



BR36010
Vassoio Love Chocolat
(pz. 53)

gr. 605 cad.



BR36011
Vassoio Sweet France
(pz. 51)

gr. 633 cad.



BR36012
Vassoio pasticcini ibridi
(pz. 24)

gr. 672 cad.

FRUTTA GELATO MIGNON



AL08
Frutta gelato piccola albicocca

kg. 2



AL09
Frutta gelato piccola castagna

kg. 2



AL10
Frutta gelato piccola fico

kg. 2



AL11
Frutta gelato piccola fragola

kg. 2



AL12
Frutta gelato piccola nespola

kg. 2



AL13
Frutta gelato prugna piccola

kg. 2



AL14
Frutta gelato arachide mignon

kg. 1



AL15
Frutta gelato dattero mignon

kg. 1



AL16
Frutta gelato mandarino cinese mignon

kg. 1



AL23
Frutta gelato noce piccola

kg. 2



AL25
Frutta gelato ciliegia (pz. 90 ca)

kg. 1,5



AL21
Mix frutta gelato mignon, datteri, fico, fragola, castagna, albicocca noce

kg. 8

FRUTTA GELATO GRANDE



AL01
Frutta gelato grande banana

kg. 1,5



AL02
Frutta gelato grande cacao

kg. 2



AL03
Frutta gelato grande fico d'india

kg. 2



AL04
Frutta gelato grande kiwi

kg. 2



AL05
Frutta gelato grande limone

kg. 2



AL06
Frutta gelato grande mandarino

kg. 2



AL07
Frutta gelato grande mela

kg. 2



AL17
Frutta gelato pera grande

kg. 2



AL18
Frutta gelato pesca grande

kg. 2



AL24
Frutta gelato grande frutto della passione

kg. 2



AL20
Mix frutta gelato grande, fico d'india, prugna, pesca, kiwi, mela, mandarino

kg. 7

PUREA DI FRUTTA

PUREA DI FRUTTA

**SI1593 - BERGAMOTTO**
Purea di frutta bergamotto Sicilia

kg. 6

**SI1594 - MELA VERDE**
Purea di frutta mela verde

kg. 6

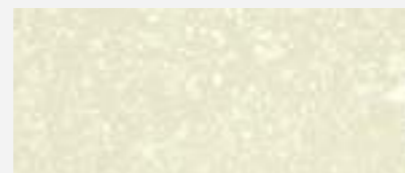
**SI1595 - COCCO**
Purea di frutta cocco con scaglie

kg. 6

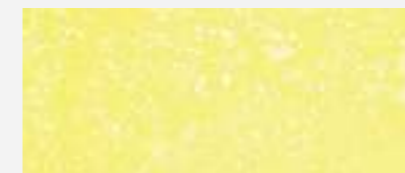
**SI1607 - PERA WILLIAM'S**
Purea di frutta pera William's Francia

kg. 6

**SI1609 - FRAGOLA**
Purea di frutta fragola

kg. 6

**SI1608 - ANANAS**
Purea di frutta ananas

kg. 6

**SI1597 - LIMONE SICILIA**
Purea di frutta limone Sicilia

kg. 6

**SI1599 - LYCHEE**
Purea di frutta lychee

kg. 6

**SI1598 - LIME**
Purea di frutta lime

kg. 6

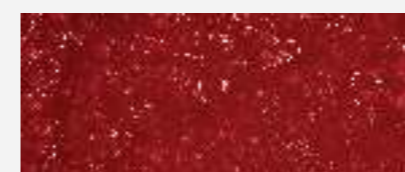
**SI1610 - FRUTTI ROSSI**
Purea di frutti rossi misti

kg. 6

**SI1611 - MIRTILLI**
Purea di frutta mirtilli selvatici

kg. 6

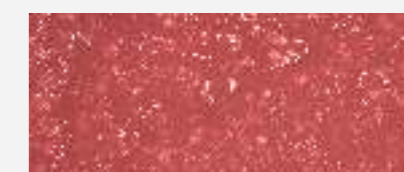
**SI1612 - LAMPONE**
Purea di frutta lampone

kg. 6

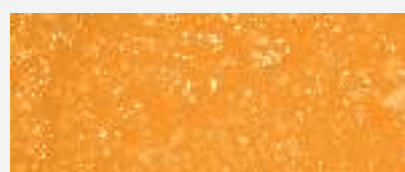
**SI1600 - MANDARINO**
Purea di frutta mandarino Sicilia

kg. 6

**SI1601 - MANGO**
Purea di frutta mango

kg. 6

**SI1602 - ARANCIA ROSSA**
Purea di frutta arancia rossa Sicilia

kg. 6

**SI1613 - RIBES NERO**
Purea di frutta ribes nero Francia

kg. 6

**SI1979 - MELONE**
Purea di frutta melone

kg. 6

**SI1614 - MORA SELVATICA**
Purea di frutta mora selvatica

kg. 6

**SI1604 - FRUTTO DELLA PASSIONE**
Purea di frutto della passione

kg. 6

**SI1605 - PESCA BIANCA**
Purea di frutta pesca bianca Francia

kg. 6

**SI1606 - PESCA GIALLA**
Purea di frutta pesca gialla Francia

kg. 6

**SI2193 - ARANCIA SICILIA**
Purea di frutta arancia Sicilia

kg. 6

**SI1980 - CILIEGIA**
Purea di frutta ciliegia

kg. 6

**SI2546 - PAPAYA**
Purea di frutta papaya

kg. 6

COMPLEMENTI

*"Tutte le grandi cose accadono
intorno ad un tavolo."*

Giorgia Fantin Borghi



- PINO - p. 50 ●
- BAMBOO - p. 52 ●
- MATER B - p. 54 ●
- PLEXIGLASS - p. 57 ●
- PORCELLANE - p. 60 ●
- VETRO - p. 62 ●

PINO



W02
Cono pino
(pz. 100/cf.)

cm 13



W03
Cono pino
(pz. 50/cf.)

cm 18



W11
Cono pino
(pz. 50/cf.)

cm 24



W10
Bicchierino foglia di pino
(pz. 100/cf.)

cm 5x2



W19
Bicchierino foglia di pino obliquo
(pz. 50/cf.)

cm 6,2x6,7



W04
Barchetta pino
(pz. 50/cf.)

cm 6x4,5



W05
Barchetta pino
(pz. 50/cf.)

cm 11,5x6,5



W06
Barchetta pino
(pz. 50/cf.)

cm 14x8



W07
Barchetta pino
(pz. 50/cf.)

cm 17x8,5

PINO

CARTA PER FRITTO



PAW01
Carta giornale per fritto
(pz. 2000)

cm 13x13,5



PAW02
Carta giornale per fritto
(pz. 1000)

cm 17x16,5



PAW03
Carta giornale per fritto
(pz. 2000)

cm 30x28,5

TOVAGLIOLI



NEUTRI
(pz. 100x38 cf.)
minimo 38 cf.

3800 pz.



COLORATI
(pz. 100x38 cf.)
minimo 38 cf.

3800 pz.



BIO
(pz. 50x38 cf.)
minimo 38 cf.

1900 pz.

BAMBOO STICK



B01 Stick nodo - (pz. 2000)

+

B01N Stick nodo nero - (pz. 2000)



B02 Stick nodo - (pz. 2000)

+

B02N Stick nodo nero - (pz. 2000)



B03

Stick nodo
(pz. 2000)



B07

Stick gondola
(pz. 2000)



B04

Stick gondola
(pz. 2000)



B05

Stick nodo
(pz. 2000)



B08

Stick gondola
(pz. 2000)

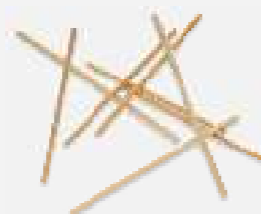

BBS011

Bastoncino legno chupa chups
(pz. 2000)



BPC110

Stick legno "vite" NERO
(pz. 2000)



B52

Stick bamboo cerchio
(pz. 1000)



BPC18C

Stick "cuore" NERO bamboo
(pz. 2000)

BAMBOO POSATE



B47N

Cucchiaino piccolo legno NERO
(pz. 200)



B47B

Cucchiaino piccolo legno
(pz. 288)



B49

Pinza legno
(pz. 240)



B48N

Forchetta piccola legno NERA
(pz. 200)



B48B

Forchetta piccola legno
(pz. 288)

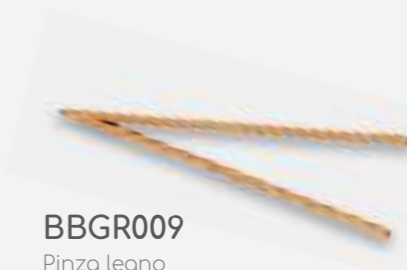

BBGR009

Pinza legno
(pz. 500)



BCB003

Lingua di "gatto" legno
(pz. 100)



BCBN03

Lingua di "gatto" legno NERA
(pz. 100)



BCBN01

Ovale bamboo NERO
(pz. 100)

MATER B - 100% cotone biodegradabile

TOVAGLIOLI senza logo



NEUTRI

Minimo cf. 1x8 (400 pz./cf)
pz. 3200 **€217,60**

COLORATI

Minimo cf. 1x8 (400 pz./cf)
pz. 3200 **€249,60**

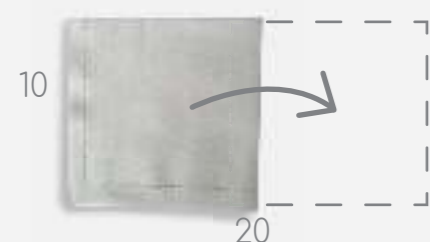

Minimo cf. 1x12 (200 pz./cf)
pz. 2400 **€288,00**

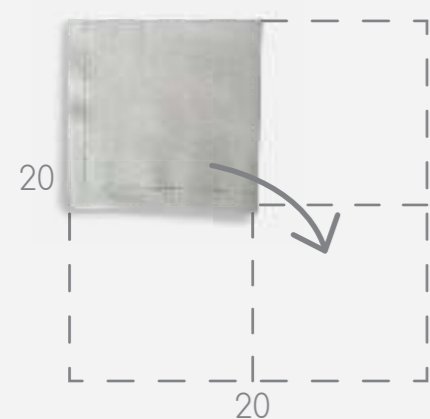

Minimo cf. 1x12 (100 pz./cf)
pz. 1200 **€220,80**

Minimo cf. 1x12 (100 pz./cf)
pz. 1200 **€259,20**

MATER B - 100% cotone biodegradabile

TOVAGLIOLI con il logo



NEUTRI

Minimo cf. 1x8 (400 pz./cf)
pz. 3200 **€265,60**

COLORATI

Minimo cf. 1x8 (400 pz./cf)
pz. 3200 **€297,60**

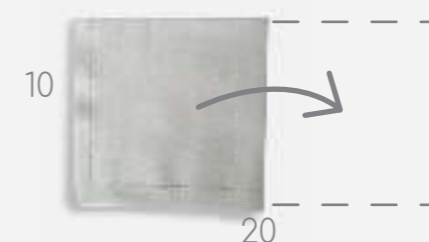

Minimo cf. 1x12 (200 pz./cf)
pz. 2400 **€336,00**

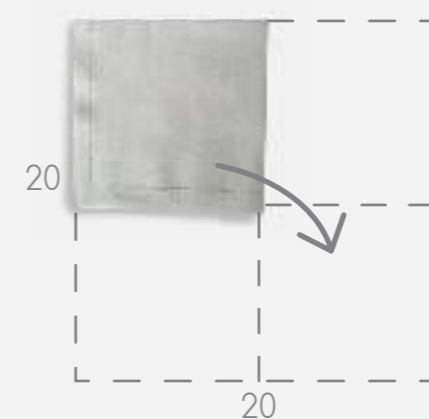

Minimo cf. 1x12 (100 pz./cf)
pz. 1200 **€252,00**

Minimo cf. 1x12 (100 pz./cf)
pz. 1200 **€288,00**

MATER B - polpa di cellulosa

POSATE E PIATTI



COCPLA05
Forchettina BIO
(pz. 500)

cm 10



COCPLA04
Cucchiaino BIO
(pz. 500)

cm 10



COCPLA06
Cucchiaino cappuccino BIO
(pz. 1000)

cm 11,5



PU01
Piatto BIO polpa cellulosa
(pz. 500)

mm 175



PU02
Piatto BIO polpa cellulosa
(pz. 500)

mm 260



PU03
Piatto quadrato BIO
polpa cellulosa - (pz. 500)

cm 26x26



PU04
Piatto rotondo BIO polpa cellulosa
(pz. 500)

mm 225



PU05
Piatto rettangolare BIO polpa
cellulosa - (pz. 500)

cm 26x13



PU06
Piatto fondina BIO polpa cellulosa
(pz. 1000)

cm 7,5x5



PU07
Piatto fondina BIO polpa cellulosa
(pz. 1000)

cm 9,5x5



PU08
Piatto fondina BIO polpa cellulosa
(pz. 1000)

cm 13,5x4,8



PU09
Piatto fondina BIO polpa cellulosa
(pz. 500)

cm 15,5x5,4



MEB15
Forchettina trasparente pl.
(pz. 500)

cm 10x2,15



MEB06
Duo cucchiaino/forchetta
trasparente - (pz. 500)

cm 10x2,15



MEB08
Cucchiaino trasparente pl.
(pz. 500)

cm 10x2,15



C06
Mini forchette argento Sobert
(pz. 1000)

cm 10



C07
Mini cucchiaino argento Sobert
(pz. 1000)

cm 10



MEB40
Stick trasparente
(pz. 1000)

cm 9



BPCPRN
Stick prima nero
(pz. 1000)

cm 9



MEB01
Cucchiaino degustazione trasp.
(pz. 200)

cm 7



MEB10
Cucchiaino asia
(pz. 200)

cm 12,4x4



MEB44
Piatto ovale trasparente
(pz. 200)

cm 6x4



GP6012-11
Coppetta bianca
(pz. 144)

cm 8,3 cc. 150

PLEXIGLASS

PLEXIGLASS



6011
Piattino medium
(pz. 192)

cm 13x13



MB23
Piattino rettangolare
(pz. 200)

cm 8x5,5 h. 1,6



MB24
Piattino rettangolare
(pz. 200)

cm 16x4,5 h. 1



6027-19
Cubo nero
(pz. 240)

cm 4,7x4,7



6113-21
Coppetta "curve"
(pz. 500)

cc. 90



MEB48
Coni piramide
(pz. 200)

cm 6x6 h. 7,5



6009
Coppetta "Pagoda"
(pz. 500)

cm 6,2x6,2 cc. 90



6100
Vaschetta medium "Pagoda"
trasparente (pz. 240)

cm 8x8 cc. 200



6109-21
Coppetta diamond trasparente
(pz. 240)

cc. 150



MEB03
Quadrato svasato
(pz. 200)

cm 7x7



MEB19
Quadrato svasato
(pz. 200)

cm 5x5,8 h. 5,8



MEB18
Diamante trasparente
(pz. 200)

cm 4,2x2 h. 4



MB21
Quadrato convesso
(pz. 200)

cm 5,5x5,5 h. 4



MB20
Rettangolo largo
(pz. 200)

cm 6,2x4 h. 4



MEB22
Rettangolo alto trasparente
(pz. 200)

cm 3,8x3,8 h. 5,3



MEB04
Coppa bassa
(pz. 200)

cm 8,5



MEB05
Coppa alta
(pz. 200)

cm 5,5



MB17
Tulipano
(pz. 200)

cm 5x5,5



MEB53
Bicchierino
(pz. 200)

cm 5x5 h. 4



MEB36
Bicchierino
(pz. 200)

cm 6,2x6,2 h. 5



MEB39
Bicchierino
(pz. 200)

cm 5x5 h. 4



PEM05
Coppetta squadrata
(pz. 200)

cm 6,2x6,2 h. 5,9



PEM07
Bicchierino squadrato
(pz. 100)

cm 7,2x4,5 h. 7



MEB16
Cilindro
(pz. 200)

cm 3,5x7,5

PORCELLANE

PORCELLANE

PIATTINI



MPS1120070
Piattino quadro bianco
(pz. 36)

cm 7,5



MPS1120075
Piattino quadro nero
(pz. 36)

cm 7,5



MPS1137070
Tortiera
(pz. 24)

cm 7



MPS1181080
Coppetta snack bianca
(pz. 12)

cm 8x6,5 h. 3,7



MPS1181120
Coppetta snack bianca
(pz. 6)

cm 11,7x9,8 h. 5,5



MPS1138140
Caffè snack
(pz. 12)

cm 10x7,5 h. 4,8



MPS1120100
Piattino quadro bianco
(pz. 36)

cm 10x10



MPS1120105
Piattino quadro nero
(pz. 36)

cm 10x12



MPS1136040
Coppettina bianca(cm 4,5 h 3,5)
(pz. 12)

cm 4,5 h. 3,5



1MPS130040
Bicchierino a spirale bianco
(pz. 12)

cm 4,5 h. 6,5



MPS1138080
Coppetta ovale
(pz. 12)

cm 8,3x3,5 h. 4,9

COPPETTE



MPS1122070
Coppetta quadra conica bianca
(pz. 12)

cm 7,3x7,3 h. 7,2



MPS1120060
Coppetta quadra bianca
(pz. 12)

cm 6x6 h. 4,8



MPS1137060
Pirottino bianco - base 4
(pz. 12)

cm 5,8x3

VETRO

COPPETTE



GL120A
Bowl vetro soffiato
(pz. 144)

cm 6,5x4,5



GL120C
Bowl vetro soffiato
(pz. 144)

cm 5x4



GL124
Bowl vetro soffiato obliquo
(pz. 108)

cm 6,5x4,5



GL132
Verrina doppia parete vetro soffiato
(pz. 48)

cm 15,5x15,5 h. 7,7



GL120B
Coupelle vetro
(pz. 72)

cm 8,8x8,3 h. 3,4



GL120D
Coppetta vetro Piramide
(pz. 72)

cm 8x8 h. 4,5

VETRO

BICCHIERINI



GL301A
Cubo vetro
(pz. 144)

cm 5x5 h. 5



GL300
Bicchierino vetro
(pz. 144)

cm 5,2x6 h. 5,8



VVE014
Cilindro vetro
(pz. 240)

cm 5 h. 3,1



VVE019
Bicchierino vetro
"gourmand" - (pz. 80)

cm 7x6,7 h. 6,3



VVE015
Bicchierino vetro
(pz. 6)

cm 6x6 h. 5,9



VVE026
Bicchierino vetro "Bodega"
(pz. 72)

cm 8,5x8,4 h. 5,5



INTORNO
AL CIBO

L'alta ristorazione è
la nostra più grande sfida.

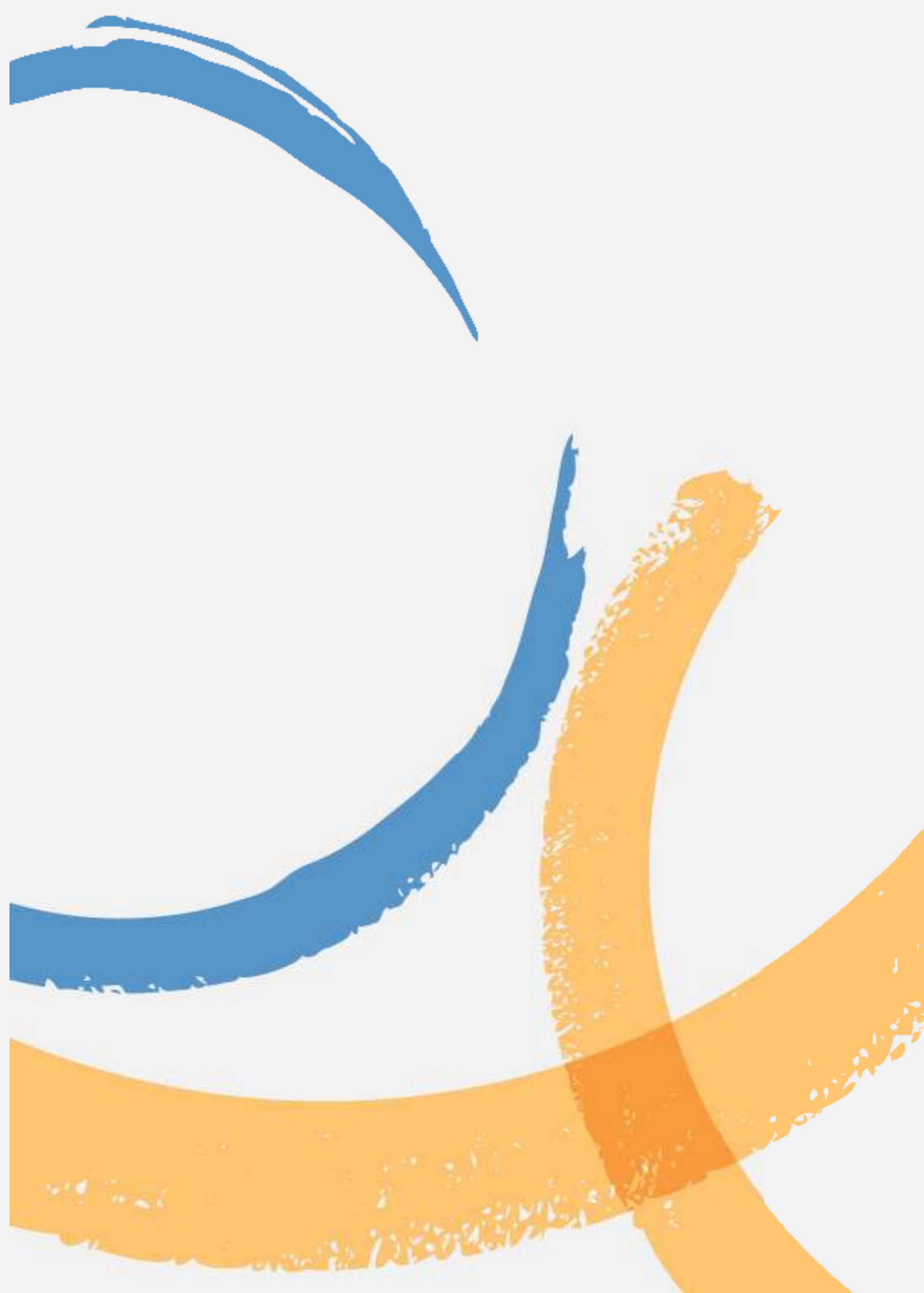

www.intornoalcibo.it

E-mail: info@intornoalcibo.it